



SUEVIA

KÄLBER / CALVES / VEAUX / TERNEROS / ТЕЛЯТА

Mod. 370-MS $\frac{1}{2}$ " Mod. 375-VA $\frac{3}{4}$ " Mod. 10P Mod. 12P-MS $\frac{1}{2}$ " Mod. 12P-VA $\frac{3}{4}$ "

101.0433 Mod. 130P / 130P-N Mod. 340 Mod. 125 Mod. 326



RINDER / CATTLE / BOVINS / BOVINOS / КРС

Mod. 20-MS $\frac{1}{2}$ " Mod. 60-MS $\frac{1}{2}$ " Mod. 25R-MS $\frac{1}{2}$ " Mod. 25R-VA $\frac{3}{4}$ " Mod. 115 Mod. 19R-MS $\frac{1}{2}$ "
Mod. 19R-MS $\frac{3}{4}$ "

Mod. 8 Mod. 18P-MS $\frac{1}{2}$ " Mod. 18P-VA $\frac{3}{4}$ " Mod. 16P-MS $\frac{1}{2}$ " Mod. 16P-VA $\frac{3}{4}$ "



MILCHKÜHE / DAIRY COWS / VACHES LAITIÈRES / VACAS LECHERAS / МОЛОЧНЫЕ КОРОВЫ

Mod. 1100-MS $\frac{1}{2}$ " Mod. 1200-MS $\frac{1}{2}$ " Mod. 1200-VA $\frac{3}{4}$ " Mod. 1200P-MS $\frac{1}{2}$ "



HEIZBARE TRÄNKEN / HEATED / CHAUFFANTS / CON CALEFACTOR / С ПОДОГРЕВОМ

Mod. 46-MS $\frac{1}{2}$ "
Mod. 46-VA $\frac{3}{4}$ "

Mod. 12P-HK-MS $\frac{1}{2}$ "

Mod. 130P-H

Mod. 25R-VA $\frac{3}{4}$ "
+ 101.0456

Mod. 41A

Mod. 43A

101.0399

200 W 400 W
100 W 101.0390 101.0392
50 W 101.0322 101.0380

101.0348 101.0346 101.0344

80 + 30 cm 80 cm 60 cm 40 cm

101.0389

24 V

2 m: 101.0861
3 m: 101.1863





THERMO-QUELL / THERMO SOURCE / TERMOFUENTE / ТЁПЛЫЙ РОДНИК



Mod. 630



Mod. 640



Mod. 850



Mod. 860



HEIZGERÄTE / HEATING UNITS / RÉCHAUFFEURS / НАГРЕВАТЕЛЬНЫЕ ПРИБОРЫ



101.0308



Mod. 300 / 303
3000 W
½" - ¾"
230 V : Mod. 303
400 V : Mod. 300



Mod. 317
3000 W
½" - ¾"
230 V



Mod. 311
3000 W
¾" - 1"
400 V



Mod. 312
6000 W
¾" - 1"
400 V



HEATFLOW
3000 W / 6000 W,
6000 W / 12000 W
¾" - 1"
400 V

LAUFSTALL / FREE STALLS / STABULATIONS LIBRES / БЕСПРИВЯЗНОЕ СОДЕРЖАНИЕ



131.1391
für/for/pour/для
Mod. 500, Mod. 600

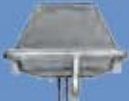

131.1392
für/for/pour/для
Mod. 520, Mod. 620



Mod. 500

Mod. 520

103.1984



Mod. 600

103.1984



Mod. 6523 - 2,3 m



Mod. ISO 6620



130.6140
55 cm



130.6150
100 cm

131.6049

131.6052



Mod. 6543 - 4,3 m



Mod. 5900 - 2,0 m



WT80 / WT80-N

WT30 / WT30-N

131.1302

131.1301



LAUFSTALL / FREE STALLS / STABULATIONS LIBRES / БЕСПРИВЯЗНОЕ СОДЕРЖАНИЕ

130.6214	1,40 m
130.6219	1,90 m
130.6223	2,30 m
130.6230	2,85 m

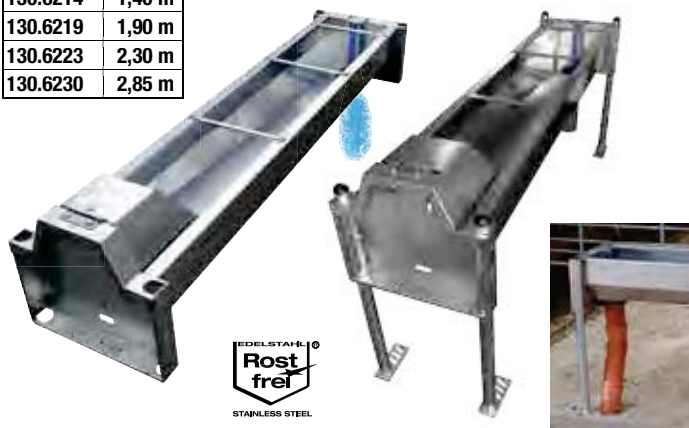

130.8721	1,0 m
130.8722	1,5 m
130.8723	2,0 m
130.8725	3,0 m



130.8731	1,0 m
130.8732	1,5 m
130.8733	2,0 m
130.8735	3,0 m

WEIDE / PASTURE / PÂTURE / PASTOREO / ДЛЯ ПАСТБИЦ



103.2020



Mod. 98



Mod. 180P



Mod. 130P-N



Mod. FT80



Mod. 8



WT200



WT400 / WT600



WT1000



WT1500



160.0305 - 500 l
160.0310 - 1300 l



Mod. 541



Mod. 545-STANDARD



Mod. 546-JUNIOR



Mod. 552-WINTERPROOF



Mod. 553-WINTERPROOF-JUNIOR



101.0557



101.0558



101.0543



101.0542



101.0550

VENTILE / VALVES / FLOTTEURS / FLOTADORES / ПОПЛАВКОВЫЕ КЛАПАНЫ



Mod. 671



Mod. 700
MAXIFLOW



Mod. 723
MASTERFLOW



Mod. 513



Mod. 874



Mod. 675



Mod. 738



Mod. 509



Mod. 475



Mod. 717



SUEVIA

KÄLBER-IGLUS / CALF HUTS / NICHES À VEAUX / CASETAS / ДОМИКИ ДЛЯ ТЕЛЯТ



MINI
146 x 116 x 115 cm



MIDI
183 x 109 x 124 cm



131.1434



131.1418



300.0013

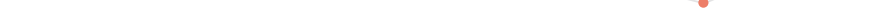

MAXI
220 x 142 x 142 cm



131.1633



COMFORT

MINI
(+ MIDI)

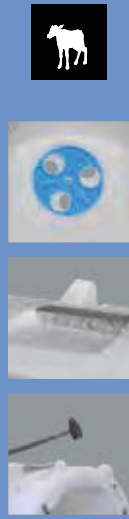

KUHBÜRSTEN / COW BRUSHES / BROSSES À VACHES / CEPILLOS / ЩЁТКИ ДЛЯ КОРОВ



TWISTER

PROFICOW-ONE

KRAZZMAXX



ZUBEHÖR / ACCESSORIES / ДОПОЛНИТЕЛЬНОЕ ОБОРУДОВАНИЕ



Mod. 210



Mod. 211



SD80



KB280

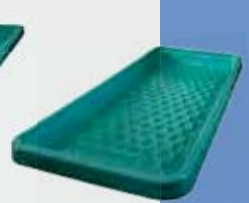

KB200



101.0466
(10P, 20)



101.0467
(115, 25R, 12P)



101.0470
(130P, 340, RUB, RUC)



101.0468
(19R)



101.0469
(10P, 20, 12P, 25R, 46, 115, 1100, 1200)



102.0249
(25R, 12P, 18P, 46, 375, 1200, 1200P)



101.1240



77 mm / 2½" -
101.1241
102 mm / 3½" -
101.1242



HEIZBARE TRÄNKEN / HEATED / CHAUFFANTS / CON CALEFACTOR / С ПОДОГРЕВОМ

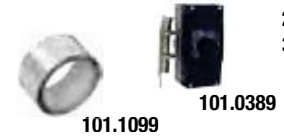
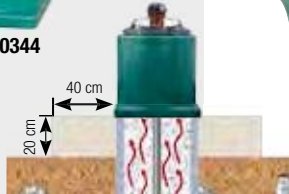
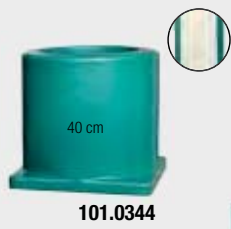

NIPPEL / NIPPLE DRINKERS / TÉTINES / СНУРЕТЫ / НИППЕЛЬНЫЕ ПОИЛКИ

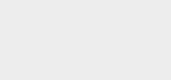

ZUBEHÖR / ACCESSORIES / ДОПОЛНИТЕЛЬНОЕ ОБОРУДОВАНИЕ

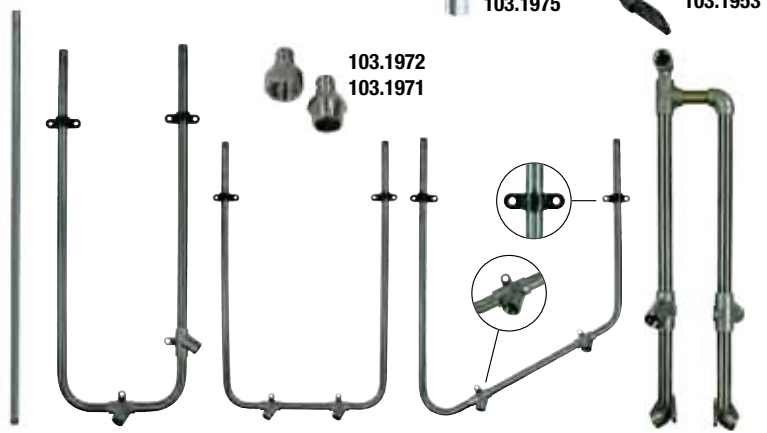
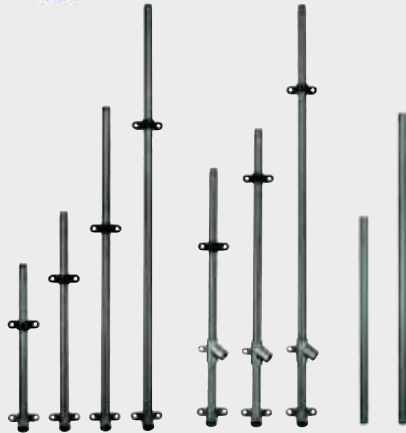



SUEVIA

FERKEL / PIGLETS / PORCELETS / LECHONES / ПОРОСЯТА



Mod. 70

Mod. 90

Mod. 140P

Mod. 92R-VA

Mod. 170P-VA



Mod. 93-VA



Mod. 72



Mod. 290



Mod. 240



Mod. 99

Mod. 899



MASTSCHWEINE / FATTENING PIGS / ENGRAISSEMENT / CERDOS / СВИНЬИ НА ОТКОРМЕ



Mod. 95S-VA



Mod. 74



SAUEN, EBER / SOWS, BOARS / TRUIES, VERRATS / CERDAS, VERRACOS / СВИНОМАТКИ, ХРЯКИ



Mod. 96-VA



Mod. 76



Mod. 20-VA½"

102.0255



MUTTERSAUEN / SOWS / TRUIES / CERDAS / СВИНОМАТКИ



Mod. 940



Mod. 370-VA½"

102.0262



100.0208



Mod. 20-VA½"



Mod. 502



Mod. 910



IN GRUPPEN /
IN GROUPS /
EN GROUPES /
EN GRUPOS /
ГРУППОВЫЕ /

SUEVIA Fachhändler / Dealer / Revendeur / Distribuidore / Дилер:

SUEVIA HAIGES GmbH

Max-Eyth-Str. 1 · 74366 Kirchheim/Neckar
Germany

+49 7143 971-0 · +49 7143 971-80

www.suevia.com · info@suevia.com

Produktdetails:



06/2016 - 104.0600